

La bibliothèque numérique Digimom

Maison de l'Orient et de la Méditerranée (MOM) - Jean Pouilloux
CNRS / Université Lumière Lyon 2

<http://www.mom.fr/digimom>

Le projet de bibliothèque numérique Digimom est issu de la volonté de la bibliothèque de la MOM de communiquer à un public élargi et/ou distant, une sélection d'ouvrages libres de droit. Il est le fruit de la collaboration entre les personnels de la bibliothèque et du Service Image.

La sélection des titres proposés répond à la fois à des besoins de conservation des originaux mais surtout à la volonté de rendre à nouveau accessibles des ouvrages rares afin de promouvoir gratuitement la diffusion du savoir et de la culture dans les champs d'investigation propres à la Maison de l'Orient et de la Méditerranée.

Dans le respect du code de la propriété intellectuelle (articles L. 342-1 et suivants), la reproduction et la communication au public des documents diffusés sur Digimom sont autorisées à condition de respecter les règles suivantes :

- mentionner la source qui a permis la reproduction de ces documents sous leur forme numérique de la façon suivante : « Digimom – Maison de l'Orient et de la Méditerranée, Lyon - France » ;
- ne pas utiliser ces documents à des fins commerciales ;
- ne pas modifier ces documents sans l'accord explicite de la MOM.

The digital library Digimom

The digital library Digimom results from the will of the library of the Maison de l'Orient et de la Méditerranée to communicate to a widened and distant public a set of royalty-free books. This project was carried out by the library staff with the technical collaboration of the Images department.

Digimom fulfills at the same time needs for conservation of the originals, and the will to make rare books once again accessible in order to promote the free of charge diffusion of knowledge and culture in the fields of investigation specific to the Maison de l'Orient et de la Méditerranée.

In the respect of the French code of intellectual property (articles L. 342-1 and following), the reproduction and the communication to the public of the documents diffused on Digimom are authorized with the proviso of complying with the following rules:

- *State the source which has enabled the production of these documents in their digital form: "Digimom - Maison de l'Orient et de la Méditerranée, Lyon – France".*
- *Do not use these documents for commercial ends.*
- *Do not modify these documents without the explicit agreement of the Maison de l'Orient et de la Méditerranée.*

RECUEIL

D'ANTIQUITÉS DE LA SCYTHIE

ATLAS

PUBLIÉ PAR LA COMMISSION IMPÉRIALE ARCHÉOLOGIQUE.

LIVRAISON I^{ER}

St.-PÉTERSBOURG.

IMPRIMERIE DE L'ACADÉMIE IMPÉRIALE DES SCIENCES.

(Vass.-Ostr., 9^e ligne, № 12.)

1866.

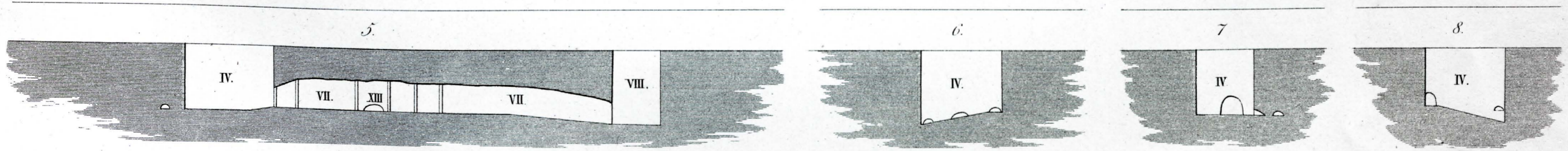
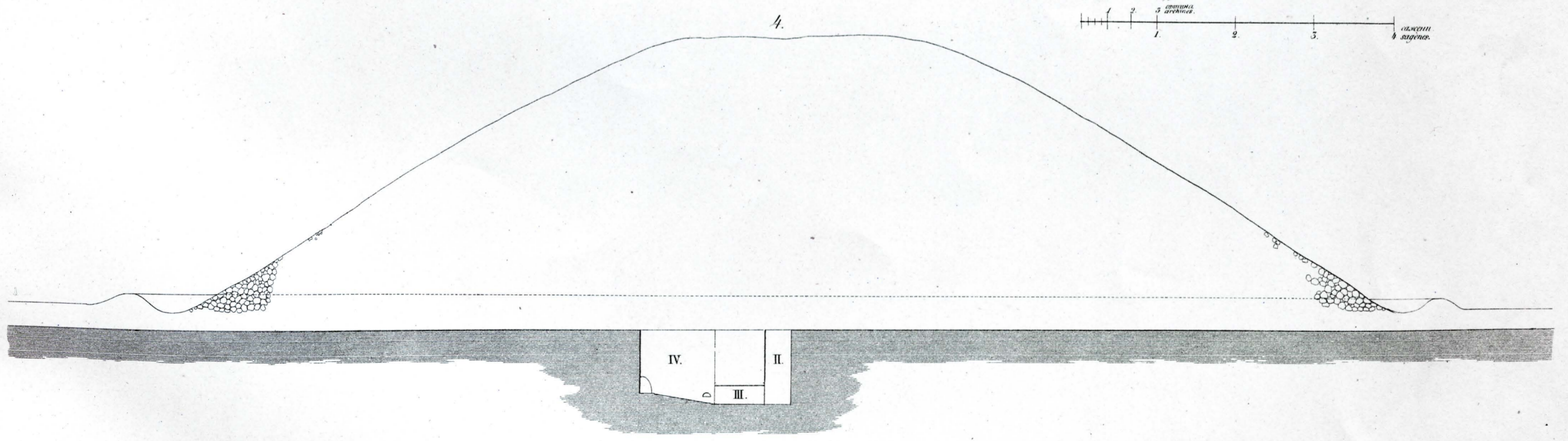
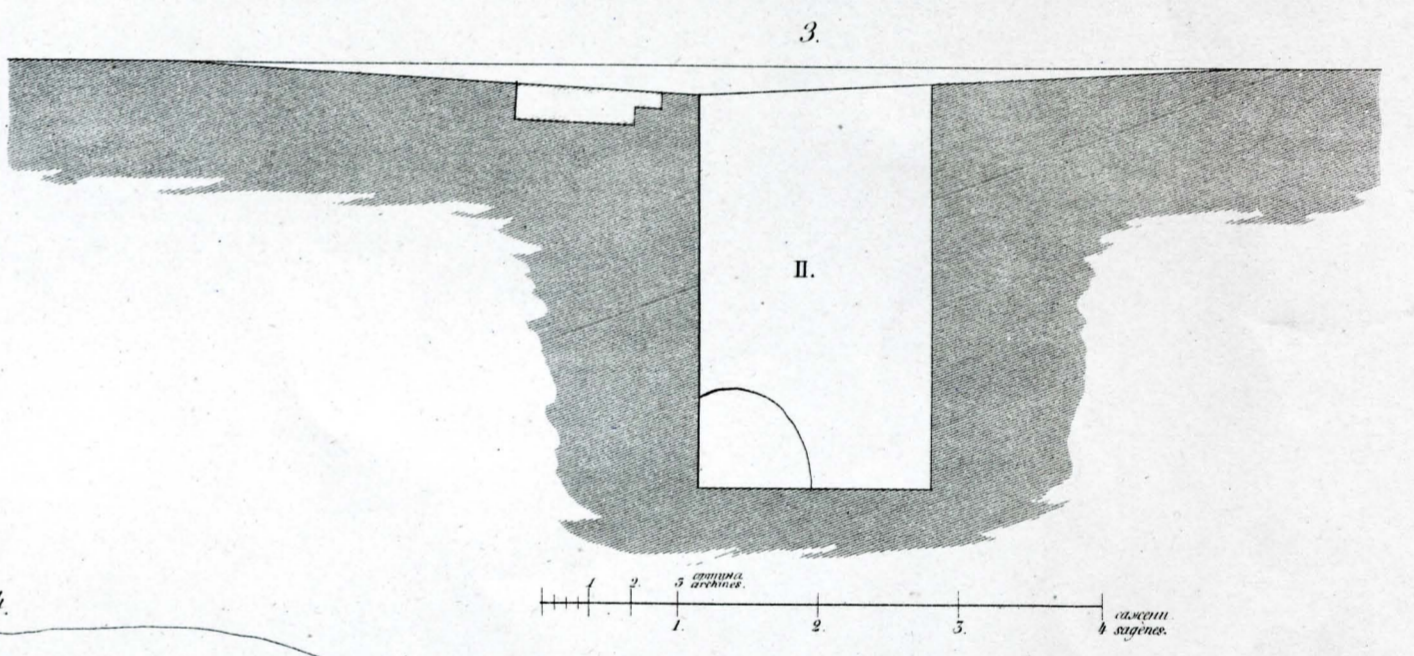
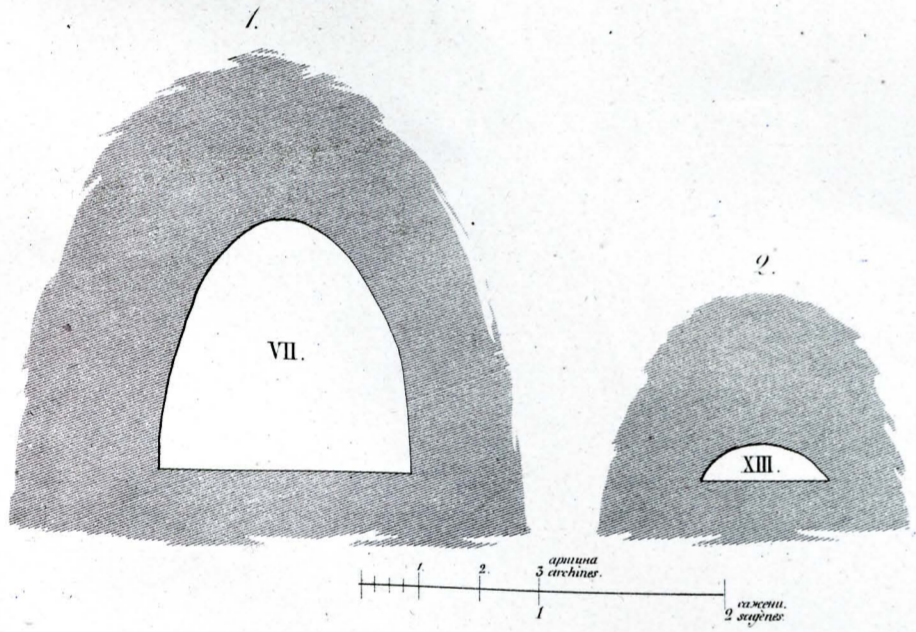
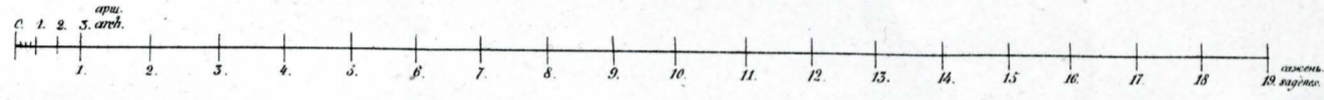
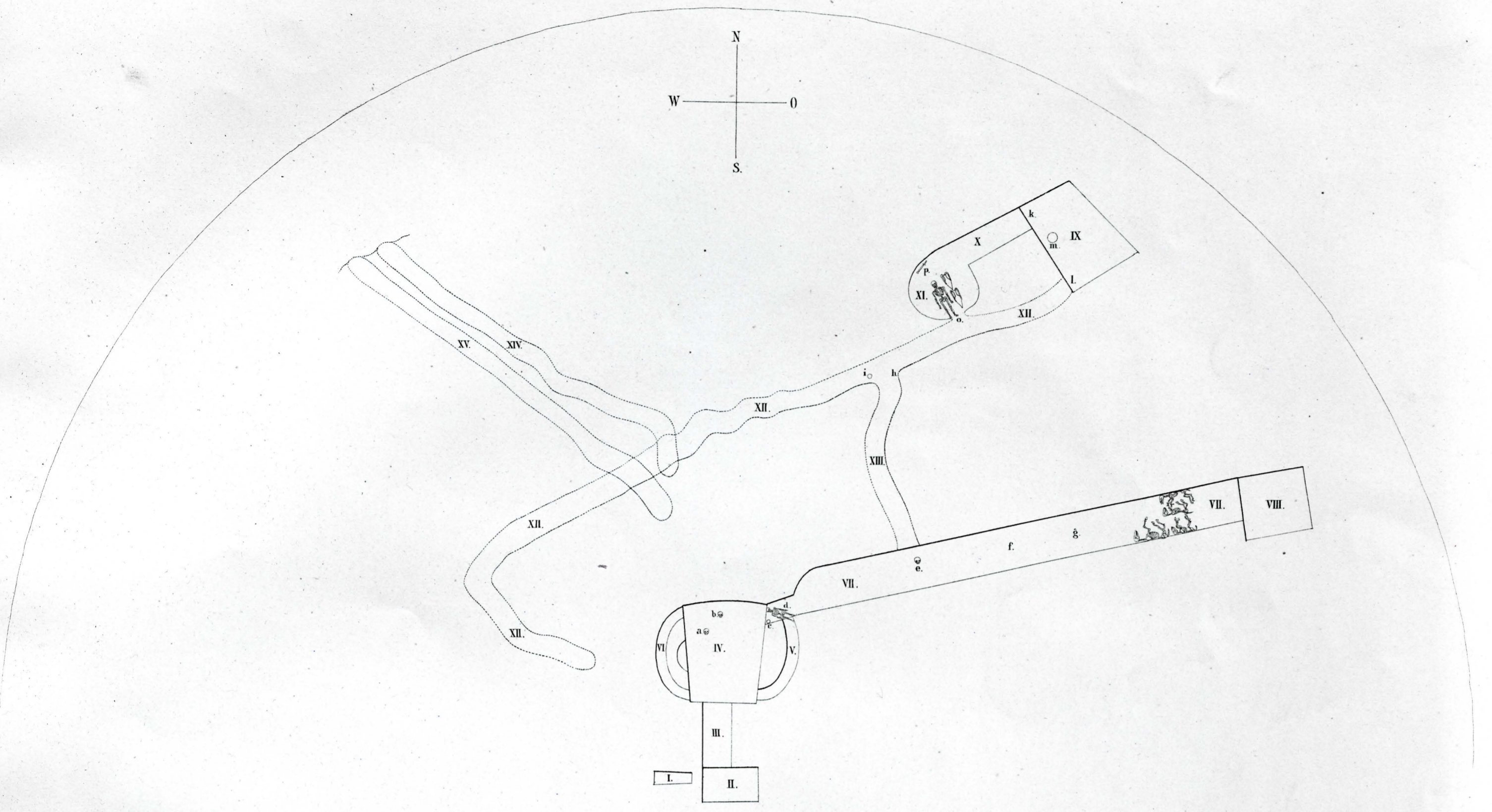

I. SITUATION ET PLANS DES TUMULI DU GUÉREMÉSOFF KHOUTOR

B.

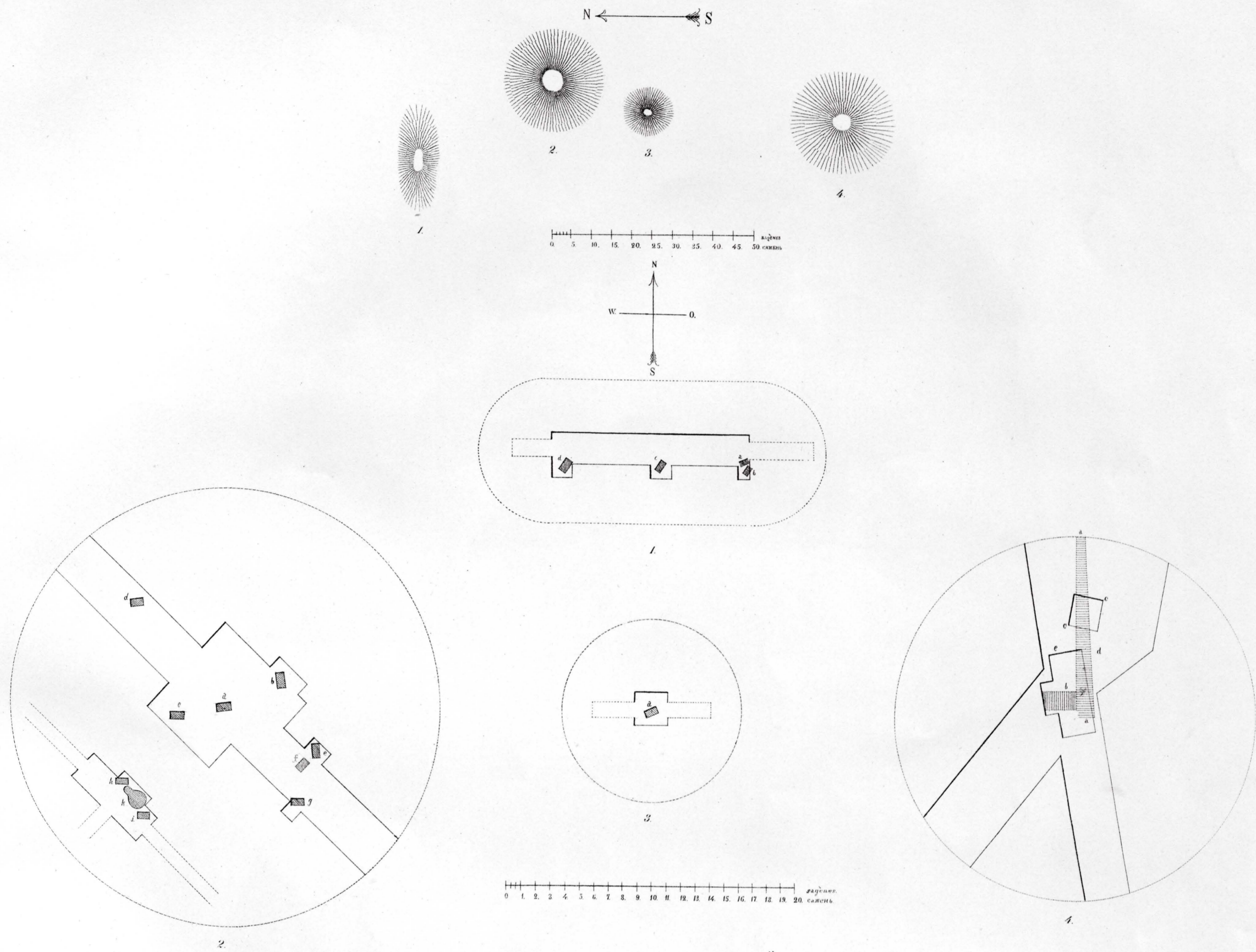

II PLAN ET COUPES DE LA DOLGAÏA MOGUILA

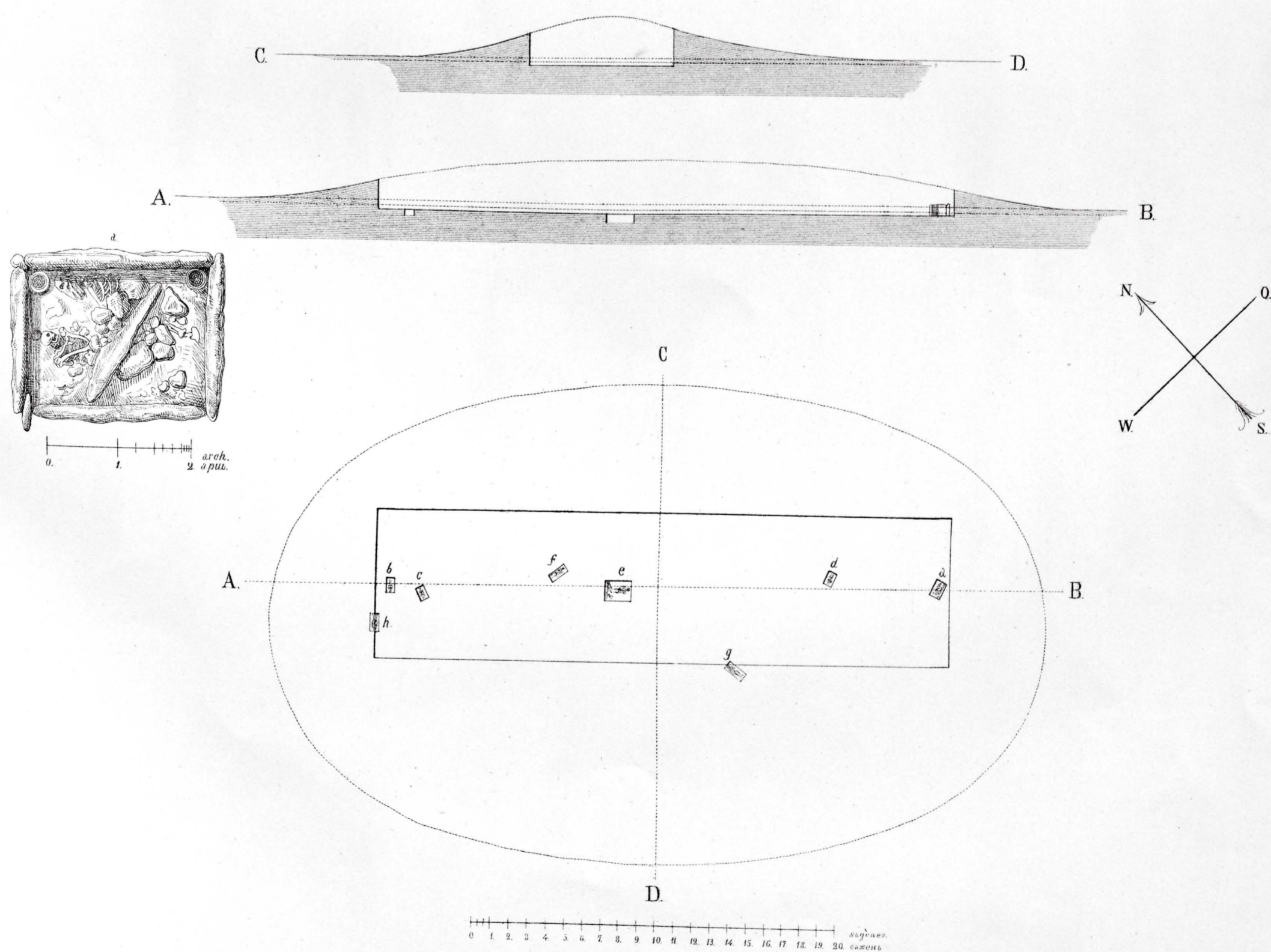





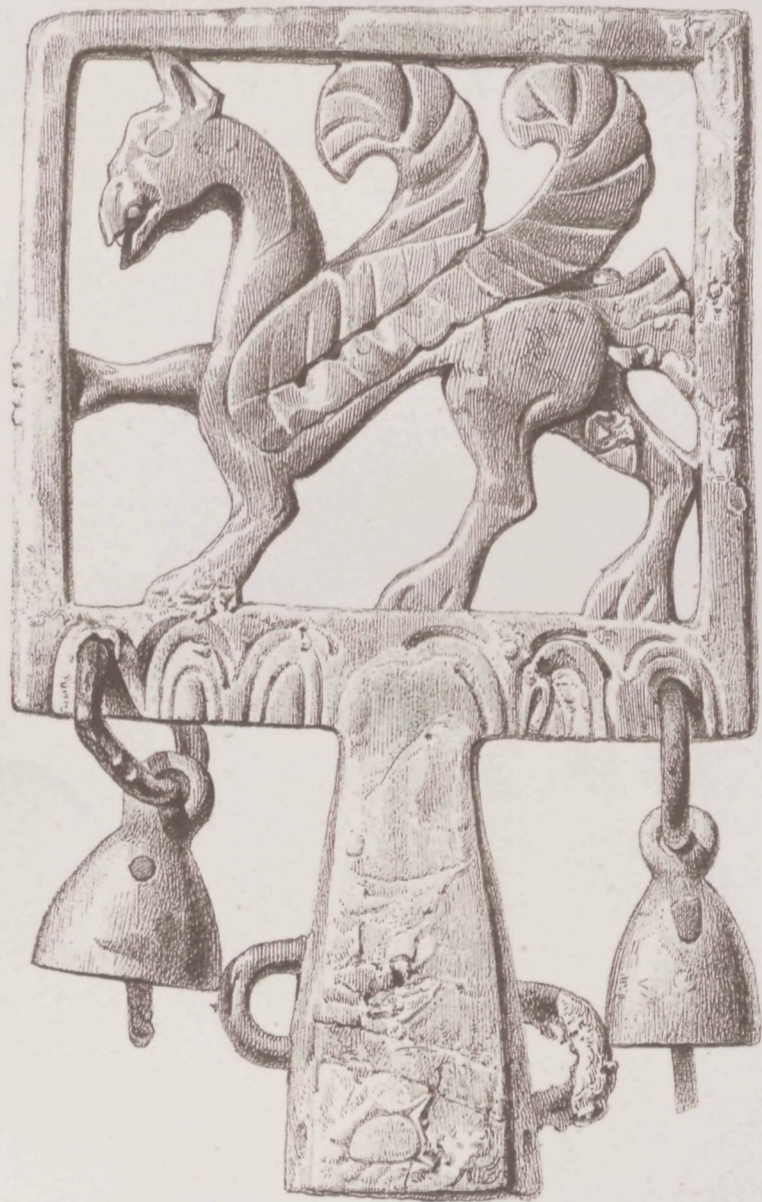

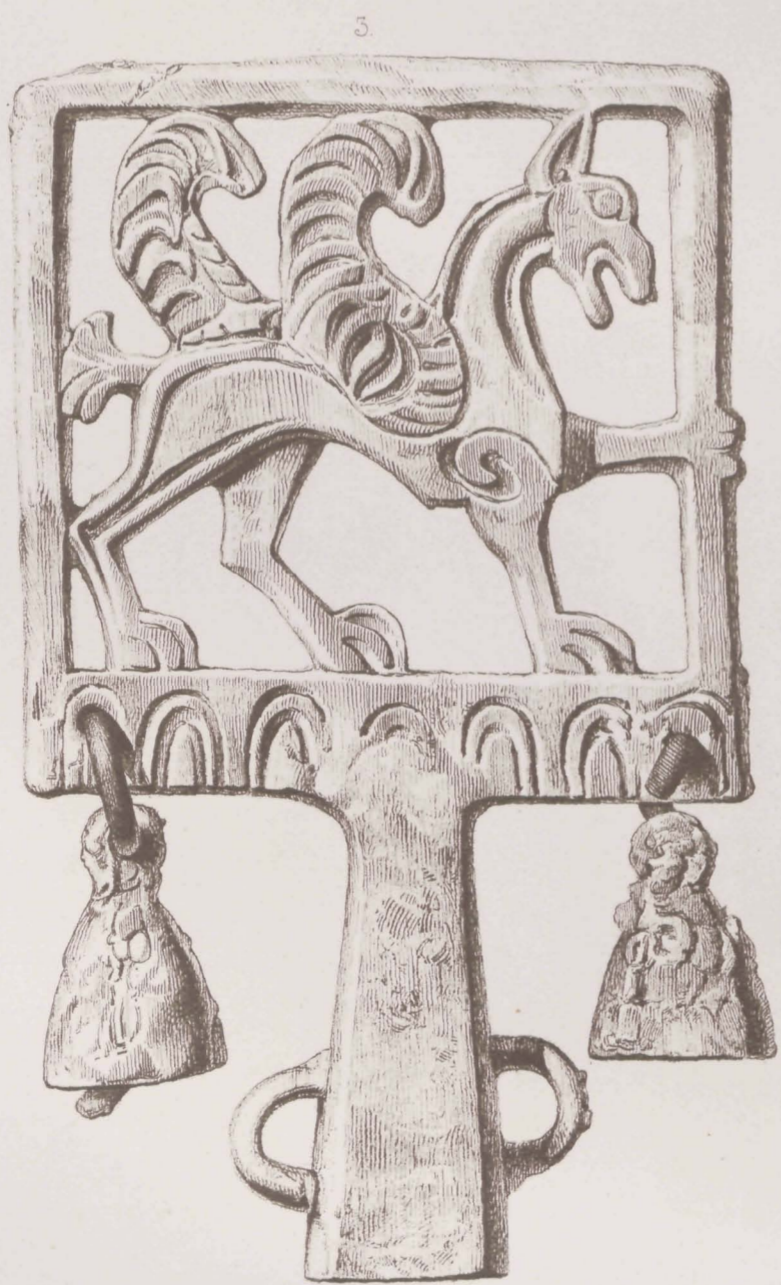
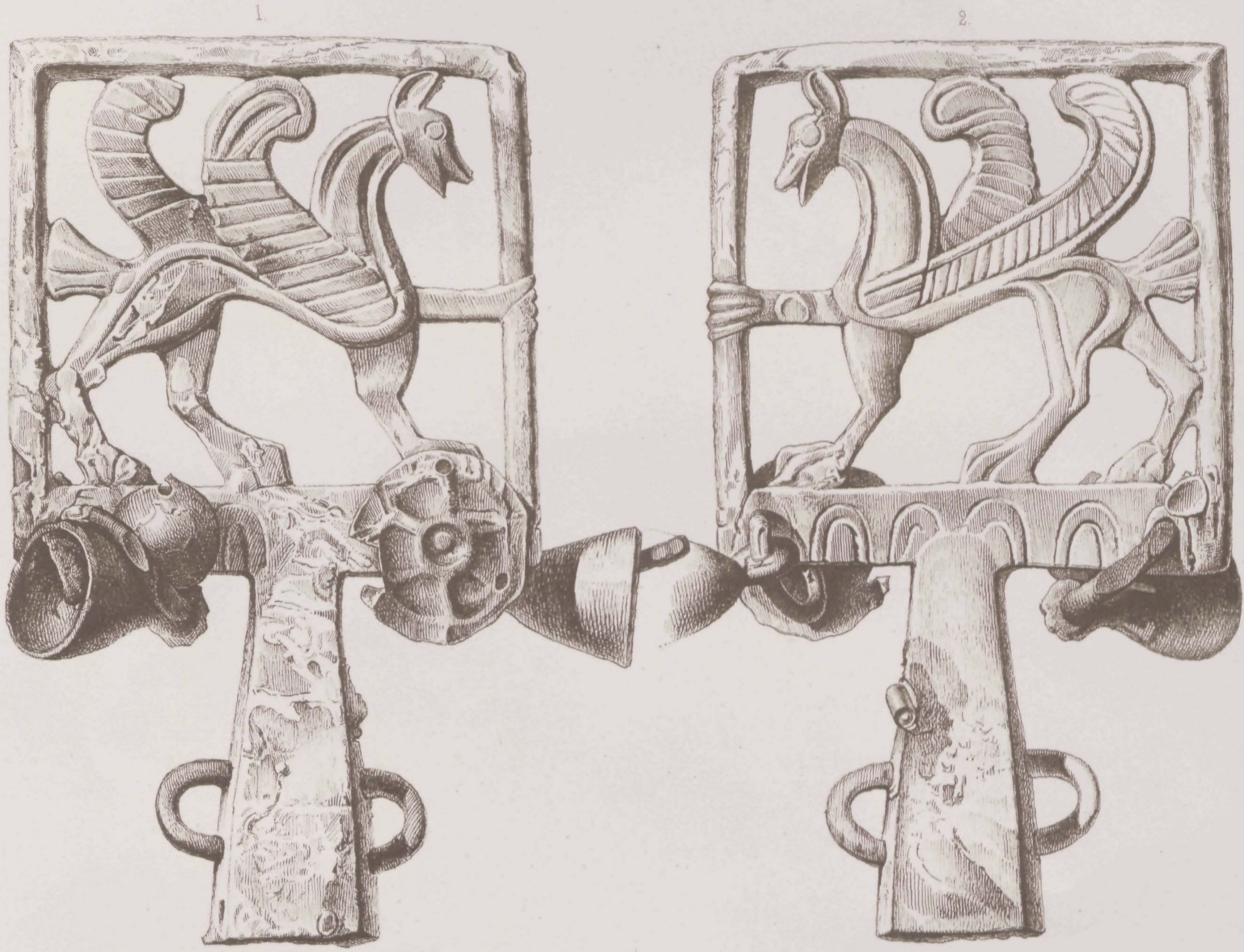

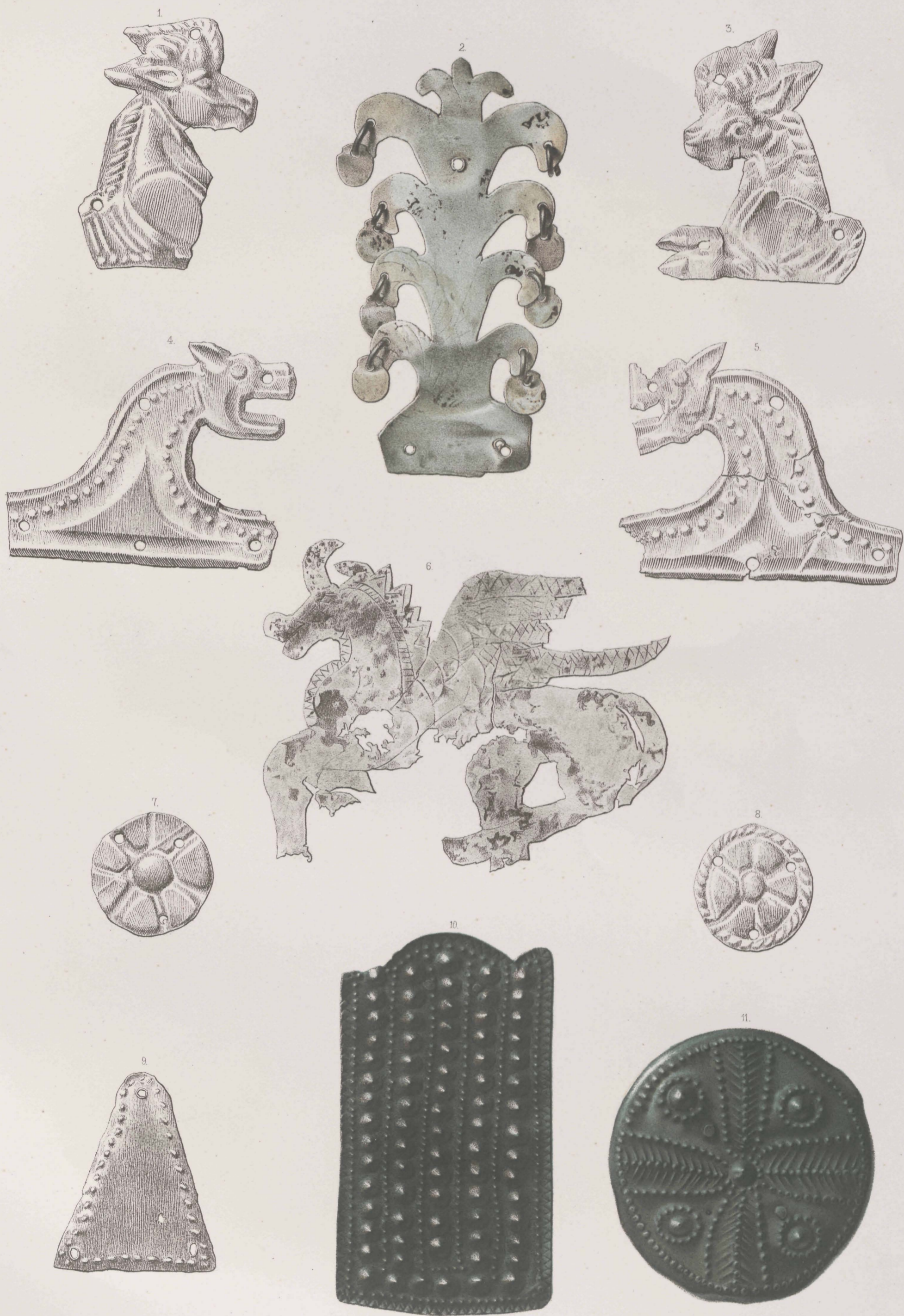















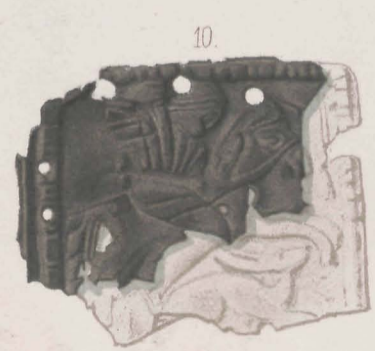

1.



2.



3.



4.



5.







1.

2.

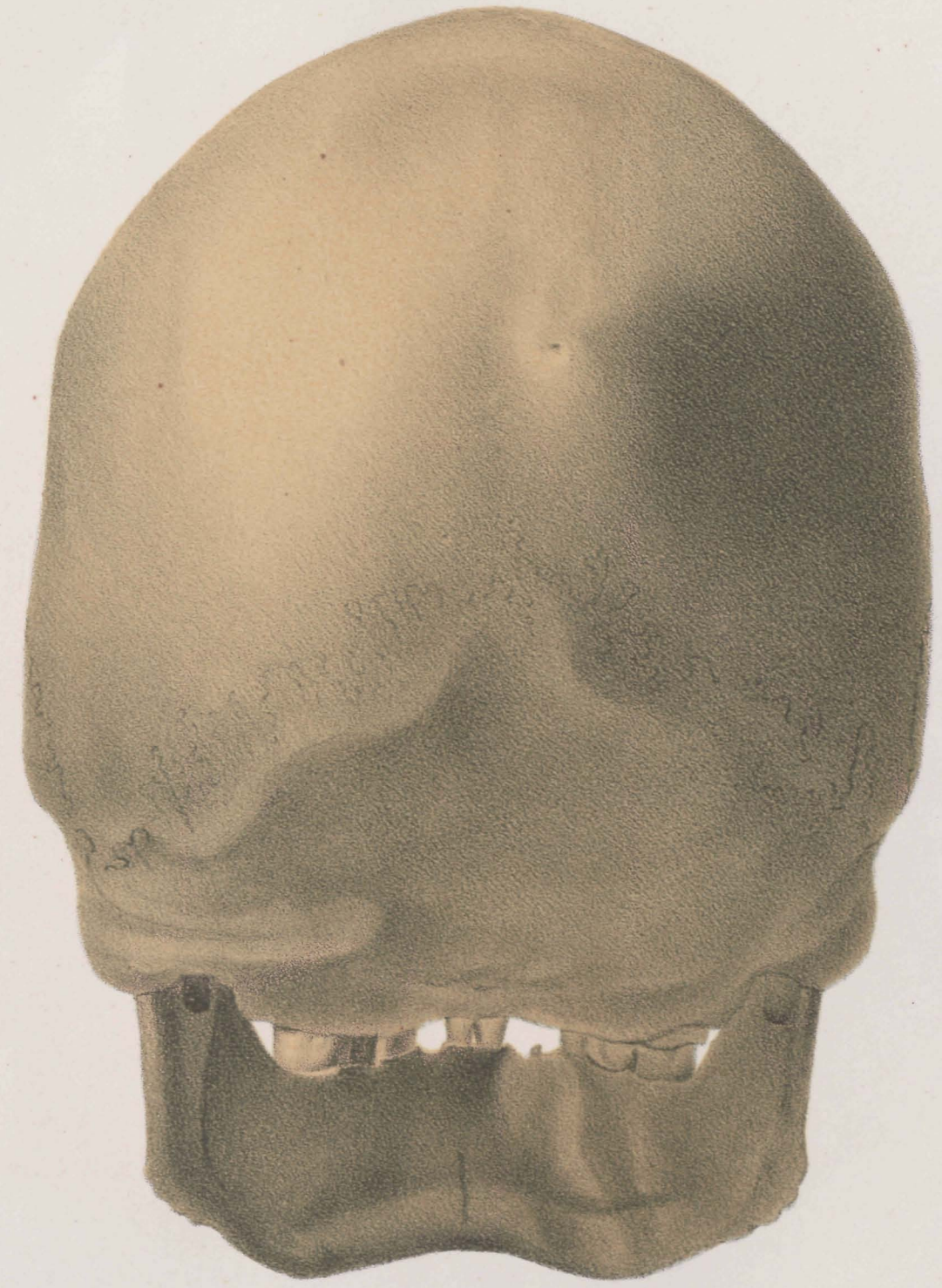

1.



2.



